

NMC-1011

8 Ports 10GbE SFP+ Network Management Card



Features

- 2x Intel XL710-BM1
- 8 ports SFP+ connector
- 1x PCIe x8, Gen3
- RoHS compliant



Specifications

Controller	2x Intel XL710-BM1
Interface	1x PCIe x8, Gen3
Speed	10GbE
Port	8x SFP+ ports
LAN LED definition	Speed LED(Left): 1Gbps: Amber on (Downgrade speed) 10Gbps: Green on (Maximum speed) Link/Act/Bypass LED(Right): Link: Green on Active: Green Blinking LAN Bypass: NA Disconnect: NA
Advanced Software Features	Teaming support IEEE 802.3ad IEEE 802.1Q VLANs IEEE 802.3 2005 flow control support Interrupt moderation
OS Support	Windows® Server 2012 R2, 2012, 2008 R2 X86-64 Linux RedHat EL 5.5 and 7.0 IA-32, X86-64, and IA-64 Linux SuSE SLES 11 SP3 and 12 IA-32, X86-64, and IA-64 FreeBSD 9 and 10 IA-32, X86-64, and IA-64 UEFI 2.1 and 2.3 X86-64 and I-64 VMware ESXi 5.1, ESXi 5.5 and ESXi 6.0 X86-64
Operating Conditions	Operation: 0 ~ 45 °C Storage: -20 ~ 60 °C
Power Voltage & consumption	+12V ± 10% 15W
Dimension (W x H x D)	74.6 x 42.4 x 174.7 mm
Compliance	CE/FCC



Front Panel Diagram

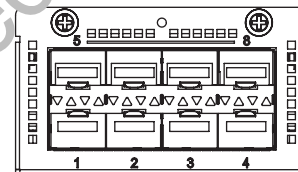

Dimensions

Unit: mm

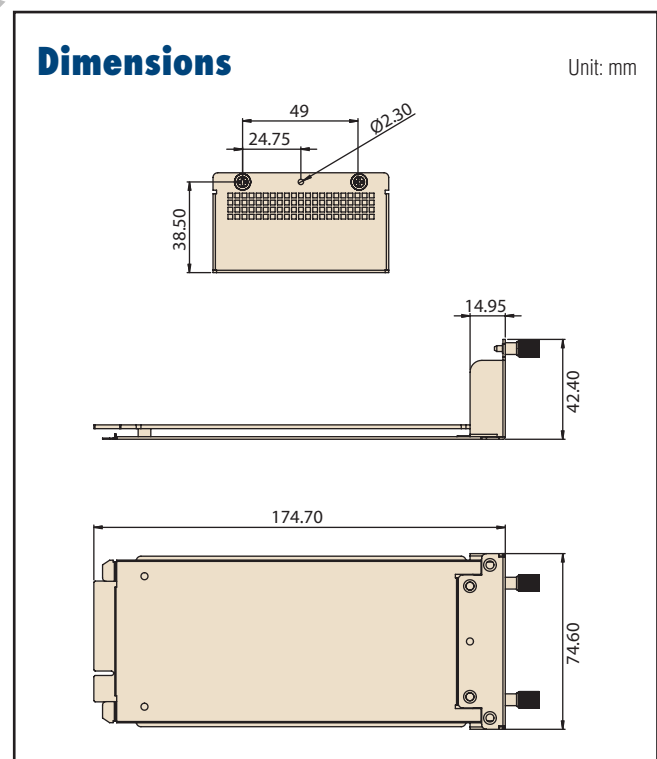

Ordering Information

Part Number	Description
NMC-1011-08FSA1	8 Ports 10GbE SFP+ Thumbscrew Type